

BMW 3 Series  
Gran Turismo



Sheer  
Driving Pleasure

[www.bmw.com](http://www.bmw.com)



# THE NEW BMW 3 SERIES GRAN TURISMO.

**BMW EFFICIENT DYNAMICS.**  
LESS EMISSIONS. MORE DRIVING PLEASURE.

THE NEXT  
100 YEARS





In 2016 the BMW brand will be celebrating its 100th anniversary. Find out more at [www.next100.bmw](http://www.next100.bmw)



## WANT TO DISCOVER MORE?

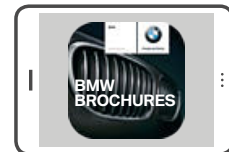

Discover the new BMW 3 Series Gran Turismo, online and interactively with video, image galleries and more. Simply download the BMW brochures app for your device and select the desired model.

Depending on your mobile phone contract, you may incur additional costs for accessing the Internet.

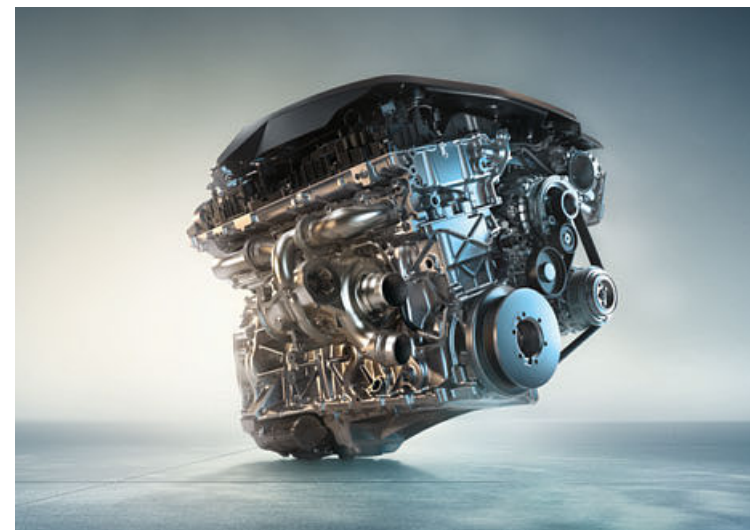

## THE BMW 3 SERIES GRAN TURISMO.

### MODEL SHOWN.

- 04 BMW 3 SERIES GRAN TURISMO 340i M SPORT PACKAGE:** BMW TwinPower Turbo in-line six-cylinder petrol engine, 240kW (326hp), 19" light alloy wheels Double-spoke style 598 M with mixed tyres, Estoril Blue metallic exterior colour, seats in Black Dakota leather with contrast stitching in Blue, Aluminium Hexagon interior trim with matt Blue highlight.

Further information on fuel consumption and CO<sub>2</sub> emissions can be found on pages 48 | 49 or consult your BMW partner.

powered by

### INNOVATION AND TECHNOLOGY.

- 18 BMW TWIN POWER TURBO ENGINES:** At the heart of BMW EfficientDynamics.
- 20 BMW EFFICIENT DYNAMICS:** Maximum driving pleasure, minimum fuel consumption.
- 22 BMW CONNECTED DRIVE:** Services & Apps and driver assistance systems.
- 24 CHASSIS:** Innovative systems for more driving pleasure.
- 26 SAFETY:** State-of-the-art technology.

### INDIVIDUALITY AND CHOICE.

- 30 EQUIPMENT:** BMW models, equipment highlights, wheels and tyres as well as Original BMW Accessories.
- 44 COLOURS:** Exterior and interior colour schemes.
- 48 TECHNICAL DATA:** vehicle weight, engine, transmission, driving performance, consumption, wheels and technical drawings.
- 50 BMW SERVICES:** BMW Service, BMW Financial Services and BMW Experience.

# SPACE.

# RACE.



The perfect interplay of size and sportiness: functional versatility and pure dynamics flow into one in the new BMW 3 Series Gran Turismo. It's a complete picture which, above all, seamlessly unites coupé-like design with the highest levels of comfort. The new BMW 3 Series Gran Turismo – fascination in space and form.



## THE REAR VIEW: RIGHT IN FRONT.

Striking lines, muscular surfaces and LED rear lights in the classic L shape – the rear profile of the new BMW 3 Series Gran Turismo is the embodiment of finely-tuned athleticism. The side view also plays its part: frameless doors and the roofline, gently sloping to the rear, are accentuated by double swage lines moving across the silhouette in a dynamic flourish to the front. This is truly forward-looking dynamism – on all sides.



## TRUST YOUR EYES. AND YOUR CAR'S.

The optional Adaptive LED Headlights for the new BMW 3 Series Gran Turismo give the best possible view to the front. A perspective that also means safety. The headlights are a striking presence in themselves. Sited next to the classic BMW kidney grille, they don't just reinforce the sporting looks of the front profile. Their visual integration with the grille also accentuates the resolute look of the vehicle on the road. Focused driving pleasure – in the new BMW 3 Series GT.



LOTS OF ROOM FOR DYNAMIC MANOEUVRE.



And efficiency. Intelligent technologies such as the BMW TwinPower Turbo engines allow the new BMW 3 Series Gran Turismo to increase dynamics to the maximum while reducing fuel consumption to a minimum. And there's always room for manoeuvre. With the Adaptive Suspension, any drive can be made more sporty, while the Active Rear Spoiler ensures even better road-holding. Efficient, aerodynamic – the new BMW 3 Series Gran Turismo.

## COMFORT THAT TOPS EVERYTHING. EXCEPT DRIVING PLEASURE.

When you enter the new BMW 3 Series Gran Turismo, you are greeted with the highest comfort: the raised seating position and the generously designed interior allow remarkable freedom of movement, even during the drive.

Personalised infotainment is another high point, thanks to the wealth of BMW ConnectedDrive<sup>1</sup> services and cutting-edge navigation systems. All this, combined with special touches such as optional ambient lighting and high-quality chrome detailing in the centre console, makes the idea of perfect travel a reality in the new BMW 3 Series Gran Turismo.



<sup>1</sup> Standard for 325d, 330d, 330d xDrive, 335d xDrive, 330i, 330i xDrive, 340i, 340i xDrive.



## A BIG IMPRESSION, WHATEVER DOOR YOU OPEN.

The flexible luggage compartment concept in the new BMW 3 Series Gran Turismo is always ready to meet your needs. Opening and closing the tailgate, for example, couldn't be easier thanks to automatic operation.

You can create yet more space, too, with the 40:20:40-divisible rear seats. They can even be folded down directly from the luggage compartment using the optional remote backrest release<sup>1</sup>. There's a place for everything – for the everyday or your next adventure – in the new BMW 3 Series Gran Turismo.



<sup>1</sup> Part of the storage package Standard for 325d, 330d, 330d xDrive, 335d xDrive, 330i, 330i xDrive, 340i, 340i xDrive.





## INNOVATION AND TECHNOLOGY.

**BMW TWIN POWER TURBO ENGINES:** At the heart of BMW EfficientDynamics.

**BMW EFFICIENT DYNAMICS:** Maximum driving pleasure, minimum fuel consumption.

**BMW CONNECTED DRIVE:** Services & Apps and driver assistance systems.

**CHASSIS:** Innovative systems for more driving pleasure.

**SAFETY:** State-of-the-art technology.

## BMW TwinPower Turbo engines. At the heart of BMW EfficientDynamics.

Thanks to BMW TwinPower Turbo technology, the innovative BMW petrol and diesel engines from the BMW EfficientDynamics family deliver agile performance and excellent responsiveness even at minimal engine speeds. At the same time, fuel consumption and emissions remain exceptionally low. It's an overall combination that guarantees significantly more intense driving pleasure.

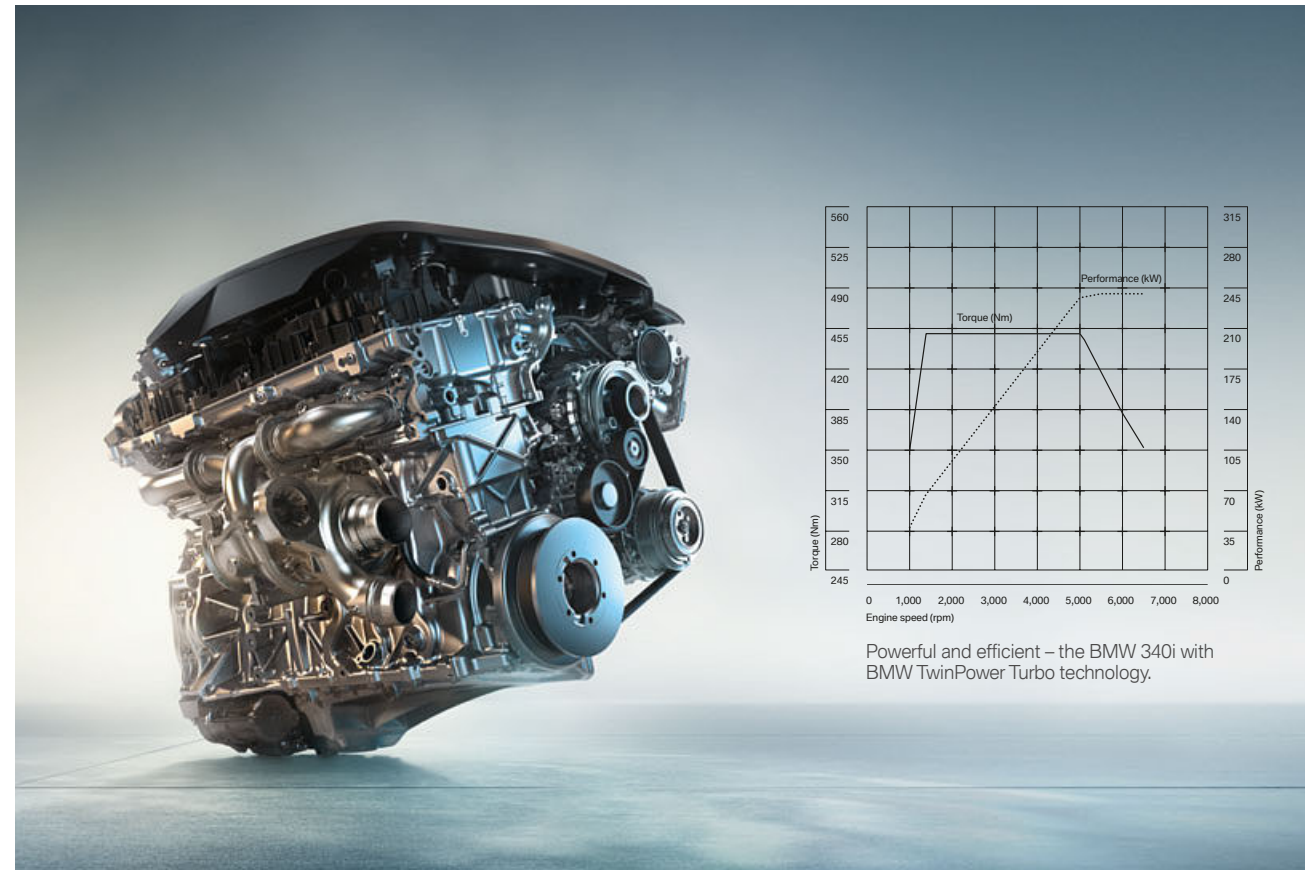

### BMW TWIN POWER TURBO IN-LINE SIX-CYLINDER PETROL ENGINE 340i.

Commanding power, silky-smooth running and a stirring sound are the hallmarks of the BMW TwinPower Turbo inline 6-cylinder petrol engine from the latest generation of the BMW EfficientDynamics engine range. With Double-VANOS, Valvetronic, High-Precision Injection and a TwinScroll turbocharger, it generates 240 kW (326 hp) and has an average combined fuel consumption rate of 7.0–7.3 litres per 100 km.

### BMW 340i/340i xDrive

- BMW TwinPower Turbo in-line six-cylinder petrol engine with 240kW (326hp) and 450Nm of torque
- Acceleration, 0–100km/h: [5.1]s (xDrive: [5.0]s); Top speed: [250<sup>2</sup>]km/h (xDrive: [250<sup>2</sup>]km/h)
- Fuel consumption, combined: [7.0–7.3] l/100km<sup>1</sup> (xDrive [7.4–7.7] l/100km<sup>1</sup>)
- CO<sub>2</sub> emissions, combined: [159–166]g/km<sup>1</sup> (xDrive [168–175]g/km<sup>1</sup>)

### BMW 330i/330i xDrive

- BMW TwinPower Turbo four-cylinder petrol engine with 185kW (252hp) and 350Nm of torque
- Acceleration, 0–100km/h: [6.1]s (xDrive: [6.2]s); Top speed: [250<sup>2</sup>]km/h (xDrive: [250<sup>2</sup>]km/h)
- Fuel consumption, combined: [5.9–6.2] l/100km<sup>1</sup> (xDrive [6.3–6.7] l/100km<sup>1</sup>)
- CO<sub>2</sub> emissions, combined: [134–141]g/km<sup>1</sup> (xDrive [145–152]g/km<sup>1</sup>)

### BMW 320i/320i xDrive

- BMW TwinPower Turbo four-cylinder petrol engine with 135kW (184hp) and 270Nm of torque
- Acceleration, 0–100km/h: 8.0 [8.1]s (xDrive: 8.1 [8.4]s); Top speed: 230 [229]km/h (xDrive: 227 [224]km/h)
- Fuel consumption, combined: 6.1–6.4 [5.8–6.1] l/100km<sup>1</sup> (xDrive 6.7–7.1 [6.3–6.6] l/100km<sup>1</sup>)
- CO<sub>2</sub> emissions, combined: 139–146 [132–139] g/km<sup>1</sup> (xDrive 154–161 [144–151]g/km<sup>1</sup>)

### BMW 335d xDrive

- BMW TwinPower Turbo in-line six-cylinder diesel engine with 230kW (313hp) and 630Nm of torque
- Acceleration, 0–100km/h: [4.9]s; Top speed: [250<sup>2</sup>]km/h
- Fuel consumption, combined: [5.6–5.7] l/100km<sup>1</sup>
- CO<sub>2</sub> emissions, combined: [148–151]g/km<sup>1</sup>

### BMW 330d/330d xDrive

- BMW TwinPower Turbo in-line six-cylinder diesel engine with 190kW (258hp) and 560Nm of torque
- Acceleration, 0–100km/h: [5.7]s (xDrive: [5.4]s); Top speed: [250<sup>2</sup>]km/h (xDrive: [250<sup>2</sup>]km/h)
- Fuel consumption, combined: [5.1–5.3] l/100km<sup>1</sup> (xDrive [5.4–5.6] l/100km<sup>1</sup>)
- CO<sub>2</sub> emissions, combined: [135–139]g/km<sup>1</sup> (xDrive [142–146]g/km<sup>1</sup>)

### BMW 325d

- BMW TwinPower Turbo four-cylinder diesel engine with 165kW (224hp) and 450Nm of torque
- Acceleration, 0–100km/h: [6.4]s; Top speed: [240]km/h
- Fuel consumption, combined: [4.7–5.0] l/100km<sup>1</sup>
- CO<sub>2</sub> emissions, combined: [124–131]g/km<sup>1</sup>

### BMW 320d/320d xDrive

- BMW TwinPower Turbo four-cylinder diesel engine with 140kW (190hp) and 400Nm of torque
- Acceleration, 0–100km/h: 7.8 [7.7]s (xDrive: 7.8 [7.7]s); Top speed: 230 [226]km/h (xDrive: 230 [225]km/h)
- Fuel consumption, combined: 4.6–4.8 [4.3–4.6] l/100km<sup>1</sup> (xDrive 4.8–5.1 [4.5–4.8] l/100km<sup>1</sup>)
- CO<sub>2</sub> emissions, combined: 120–127 [113–120]g/km<sup>1</sup> (xDrive 126–133 [119–126]g/km<sup>1</sup>)

### BMW 318d

- BMW TwinPower Turbo four-cylinder diesel engine with 110kW (150hp) and 320Nm of torque
- Acceleration, 0–100km/h: 9.3 [9.2]s; Top speed: 210 [210]km/h
- Fuel consumption, combined: 4.5–4.7 [4.3–4.5] l/100km<sup>1</sup>
- CO<sub>2</sub> emissions, combined: 117–123 [112–119]g/km<sup>1</sup>

**BMW EFFICIENT DYNAMICS.**  
LESS EMISSIONS. MORE DRIVING PLEASURE.

<sup>1</sup> Fuel consumption and CO<sub>2</sub> emissions figures depend on the selected tyre format (respective higher figures refer to models with optional wheels). Further information on fuel consumption and CO<sub>2</sub> emissions can be found on pages 48 | 49 or consult your BMW partner.

<sup>2</sup> Electronically restricted.

Quoted performance, fuel consumption and CO<sub>2</sub> emissions figures refer to vehicles with standard transmission. Figures in [ ] refer to vehicles with Steptronic transmission.

# BMW EFFICIENTDYNAMICS

## Less emissions. More driving pleasure.

BMW EfficientDynamics is the strategy developed by BMW to minimise fuel consumption and CO<sub>2</sub> emissions while simultaneously maximising dynamics and driving pleasure. It's a comprehensive package of measures that includes the drivetrain, energy management and the overall vehicle concept – and is standard in every BMW.

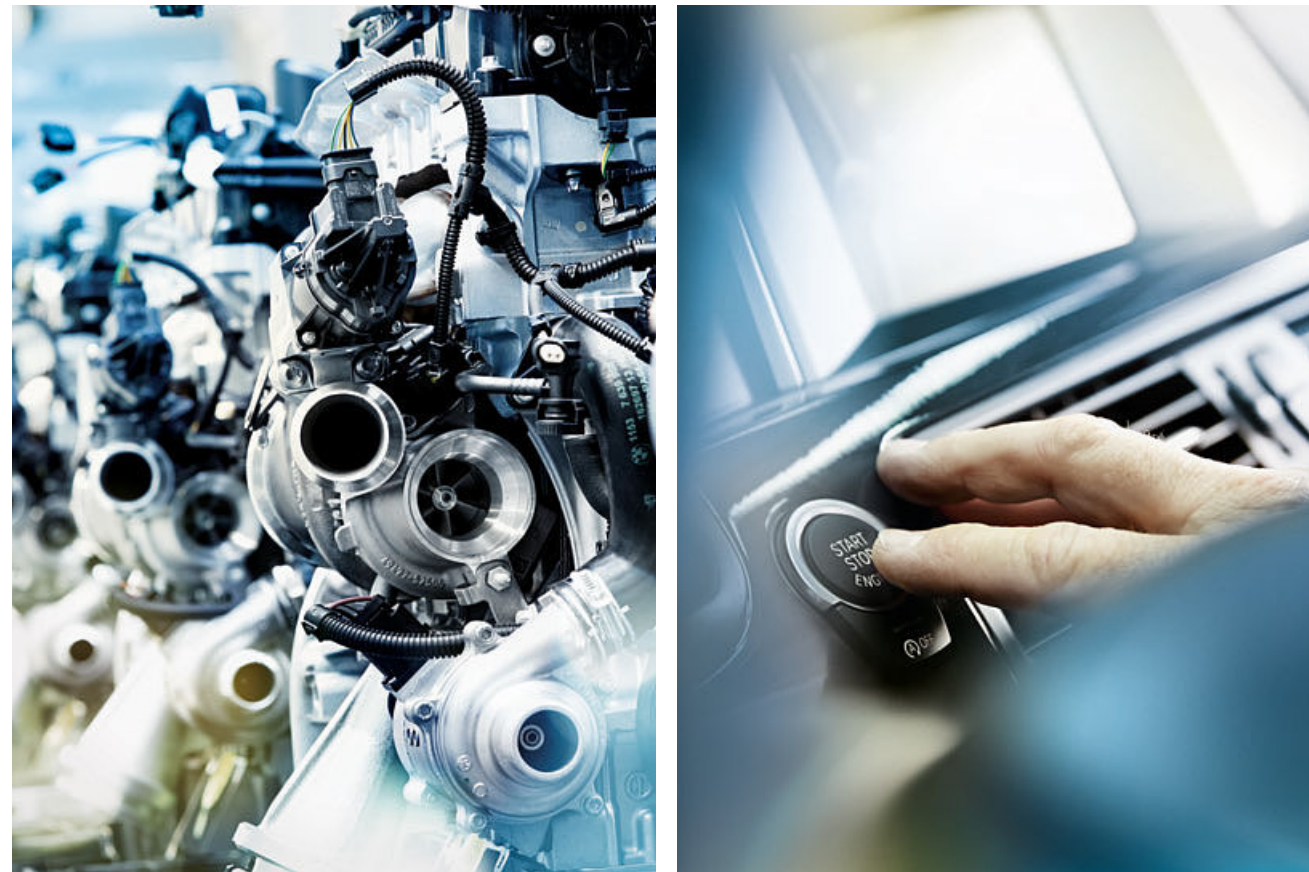

### AERODYNAMICS.

Every BMW boasts excellent air resistance figures, thanks to a range of aerodynamic elements that complement each other perfectly. This, in turn, has a positive effect on efficiency and fuel consumption. Features include a flat underbody and optimised wing mirrors.



### DRIVETRAIN.

The new-generation **BMW TwinPower Turbo petrol engines** feature remarkably agile power delivery and excellent responsiveness, even at low engine speeds. At the same time they are more efficient, with fewer emissions and better performance than their predecessors.

The latest generation of **BMW TwinPower Turbo diesel engines** is characterised by outstanding responsiveness and agile power delivery at all engine speeds. They are also breathtakingly dynamic, fuel-efficient and produce few emissions.

### OVERALL CONCEPT.

Intelligent lightweight construction at BMW means using the right material for the right parts of the vehicle. For every single component, the most suitable material is selected. This philosophy, also known as **BMW EfficientLightweight**, is now integral to BMW EfficientDynamics and applied to every BMW.

### ENERGY MANAGEMENT.

The **Route-ahead assistant**<sup>1</sup> is a function included in the ECO PRO mode and it helps the driver to adopt an extremely efficient way of driving. In conjunction with the Navigation system Professional, it recognises speed limits, city limits, bends, roundabouts, turns and motorway exits along the chosen route and gives tips in advance about when to reduce speed.

Automatically extending at a speed of over 110 km/h, the **Active rear spoiler** lends added downforce on the rear axle, thereby improving stability at high speed. It retracts automatically once the speed goes back down to under 70 km/h. The driver can also manually extend/retract the Active rear spoiler via a button below the electric window controls on the driver's door.

<sup>1</sup> The Route-ahead assistant is only available in conjunction with Navigation System Professional.

# BMW ConnectedDrive

## So connected, you're free.

Our world is becoming more connected every day. BMW drivers, however, enjoy better connections than most. They can access information, communicate by telephone and email, keep a close eye on the traffic and generally stay up to date while on the move. The innovations that so effectively network BMW vehicles with the outside world are grouped under one term – BMW ConnectedDrive.<sup>1</sup>



The **ConnectedDrive Services** option provides the basis for a wide range of information, entertainment and service features while on the road.

They include BMW Online, which gives access to current, localised information such as weather and news as well as online searches powered by Google™ and various office functions. Using the Applications menu, you can combine an array of specific services and features such as webcams, fuel pricing, parking information and travel and hotel guides.

Secure and unlimited use of selected smartphone apps is included for an unlimited period. The ConnectedDrive Services option provides access to the **BMW ConnectedDrive Store**, where services and apps can be selected and extended according to individual needs at any time and from any place. The ConnectedDrive Services option also offers much more to make each journey in your BMW an enjoyable experience in every way.

<sup>1</sup> Image shows features that are only available for the German market.

<sup>2</sup> For further information on BMW ConnectedDrive, particularly regarding the duration of services and associated costs, please consult your BMW partner or visit [www.bmw.com/ConnectedDrive\\_Information](http://www.bmw.com/ConnectedDrive_Information).

<sup>3</sup> The visibility of the BMW Head-Up Display is limited by polarised sunglasses. Functionality shown is dependent on equipment. Further optional equipment is required for additional on-screen functions.

<sup>4</sup> Expected to be available in the second half of 2016.

BMW ConnectedDrive presents a wide range of intelligent services and assistance systems, allowing you to choose precisely what you need. **BMW ConnectedDrive Services & Apps** offer more freedom through versatile connections between the driver, vehicle and outside world. **BMW ConnectedDrive Driver Assistance** makes driving a BMW even safer and more comfortable. And intelligent systems make life easy for the driver and minimise the dangers of traffic.



The full-colour **BMW Head-Up Display**<sup>2</sup> projects information relevant to the journey directly into the driver's field of vision, thereby allowing them to fully concentrate on driving. The display includes information such as the current speed, navigation directions, Speed Limit Info incl. no-overtaking indicator, along with telephone and entertainment lists.

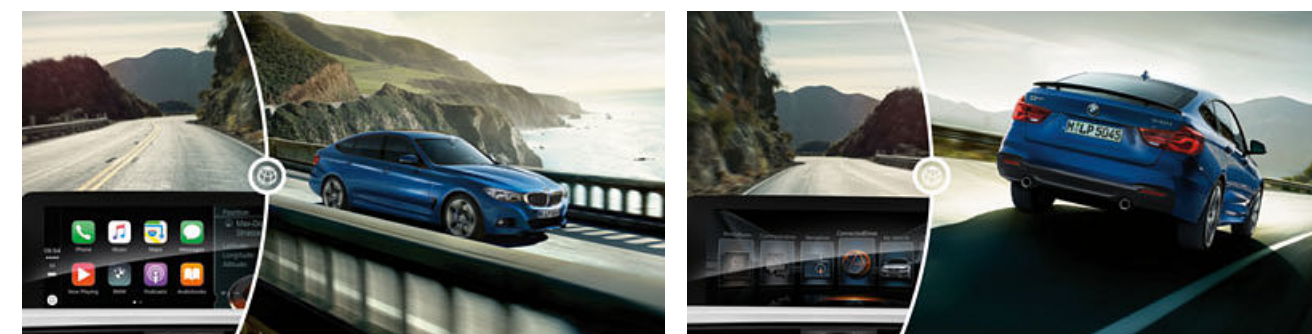

Preparation for **Apple CarPlay**<sup>3,4,5</sup> supports the convenient and secure wireless use of a compatible iPhone® in the vehicle. This allows smartphone content, along with functions such as music, iMessages/text messages, telephony, Siri and selected third-party apps, to be displayed and operated in the regular manner via the vehicle's user interface.

The **Navigation system Professional**<sup>6</sup>, including hands-free facility, USB interface, 8.8" LCD colour display and Radio BMW Professional with a DVD player, comes with a three-dimensional map display and 20 GB of memory. The system is operated intuitively via the iDrive Touch Controller. Automatic map updates are available for three years without license fees.

<sup>4</sup> ConnectedDrive Services, the Professional Navigation system and Convenience telephony with extended smartphone connectivity are required for use.

<sup>5</sup> Compatibility and functionality of the iPhone® with Apple CarPlay® is dependent on model year and installed software version.

<sup>6</sup> Automatic map updates are available for three years without a licence charge from authorised BMW dealers. As part of BMW ConnectedDrive, the system automatically updates the maps in selected European countries up to four times a year for three years.

## Chassis.

### A solid foundation for superior driving dynamics.

The new BMW 3 Series Gran Turismo features a wide range of innovative technologies that enable you to enjoy every drive to the full. Many of these systems are intelligently linked. It's this level of integration that delivers the best possible safety, together with maximum driving pleasure – on every road and every curve, every second.

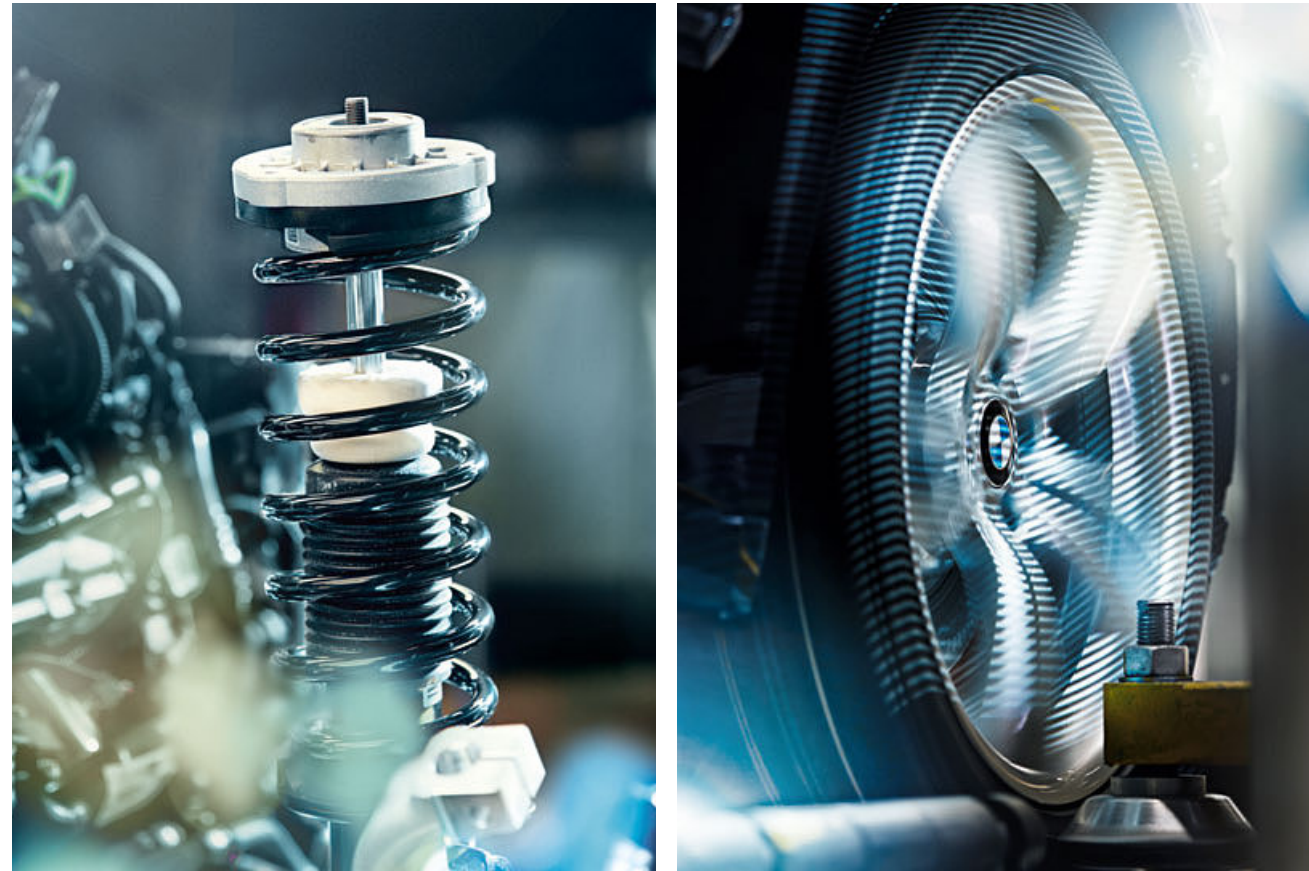

#### EIGHT-SPEED STEPTRONIC SPORT TRANSMISSION.

The automatic 8-speed Steptronic Sport transmission enables not only automatic gear selection but also manual shifting using either the gear lever or the gearshift paddles on the steering wheel. Anything is possible, from comfortable gliding to very dynamic driving with Launch Control activated if desired. In SPORT mode, the gear shifts are configured for maximum performance.



The **Adaptive M suspension**<sup>1</sup> can be electronically adjusted at any time to suit the road and driving conditions. The driver can also adjust the suspension characteristics via the Driving Experience Control to enable their preferred driving style at the time – from comfortable to extremely athletic with markedly agile handling.

The **M Sport suspension**<sup>2</sup> is characterised by sport suspension settings, and on cars with rear-wheel drive, it includes a chassis lowered by around 10 millimetres. It features shorter suspension springs and tighter damper settings, as well as harder stabilisers. Together these result in even more direct settings that facilitate a particularly dynamic driving style.

The **Variable sport steering** with Servotronic creates a direct and agile steering response and ensures less physical effort is required to turn the wheel. It reacts to the angle of the steering wheel with varying steering ratios. This improves handling when driving more dynamically and reduces the effort needed to steer when parking and turning.

**Servotronic** supports steering by adjusting the power steering to suit the current speed and ensures an immediate and precise steering response at higher speeds. What's more, it boosts steering support and therefore also comfort levels when steering at lower speeds, for example when parking or manoeuvring.

The intelligent **BMW xDrive all-wheel drive system** smoothly and variably distributes drive power to the front and rear wheels for maximum traction, driving dynamics and safety in every driving situation. For even better agility, the electronically controlled power distribution counterbalances over and under-steering on bends, among other things.

The **rear-wheel drive** ensures excellent unimpaired steering precision due to the fact that the front axle is not affected by any form of torque steer with this type of drive. Furthermore, the dynamic axle load distribution associated with a Rear-wheel drive ensures great traction when accelerating from a standstill.

<sup>1</sup> Lowering only available in conjunction with rear-wheel drive.

<sup>2</sup> M Sport suspension only available in conjunction with rear-wheel drive.

## Safety.

### Unparalleled safety with the latest BMW technology.

The new BMW 3 Series Gran Turismo is equipped with cutting-edge technologies for every eventuality. Superb handling and innovative equipment come as standard. Drivers benefit from the very latest technologies that ensure optimal support at all times. You'll feel safe and protected, no matter where your journey takes you.



#### DRIVING ASSISTANT.

Driving Assistant<sup>1</sup> combines the Lane Departure Warning and Approach control warning systems. When travelling at speeds between 10 and 60 km/h, the Approach control and person warning with light city braking function issues a warning if there is a risk of collision with vehicles or pedestrians, and brakes the vehicle in the event of an emergency. At speeds above approx. 70 km/h, the Lane Departure Warning draws the driver's attention to an unintentional lane change by means of slight vibrations of the steering wheel.

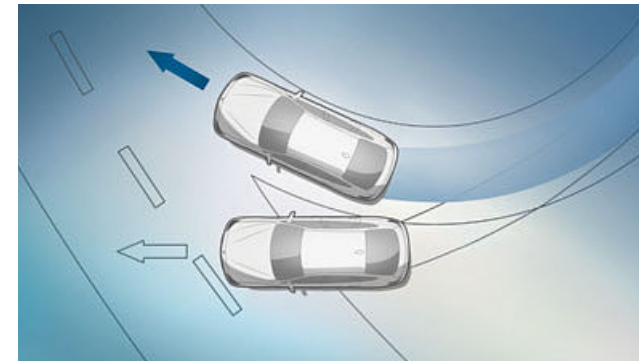

■ The **Dynamic Stability Control (DSC)** with extended functionality stabilises the vehicle as soon as any skidding motion is detected.

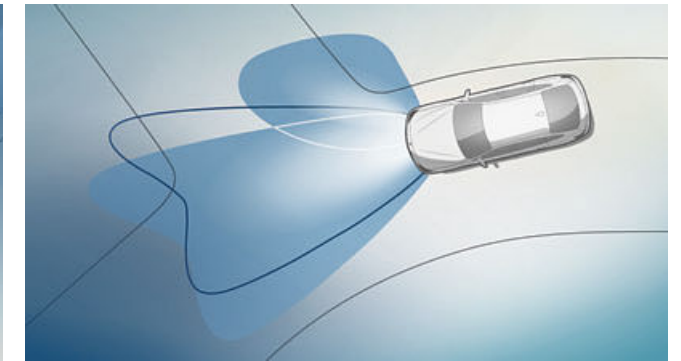

□ The **Adaptive LED headlights** produce a light colour very similar to daylight and adjust their light distribution automatically according to speed and steering angle.

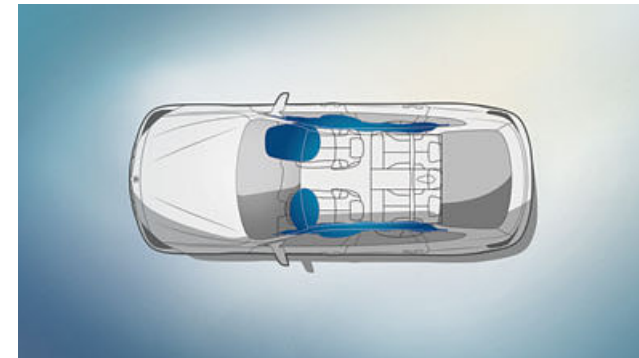

■ The **Airbags for the driver and front passenger**, as well as side airbags integrated into the front seat backrests provide strategic protection in the event of a crash.

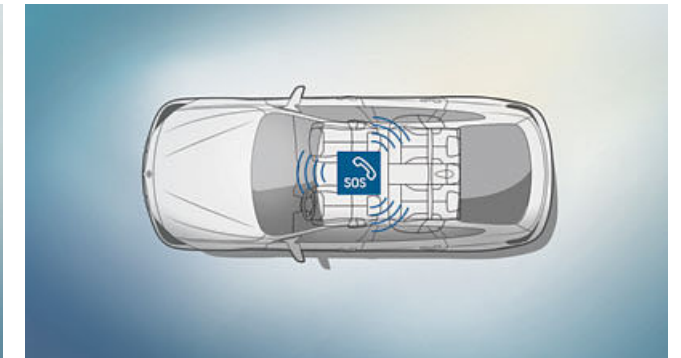

■ **Intelligent emergency call** automatically establishes a connection with the nearest rescue coordination centre through the BMW call centre whenever needed – without the use of a mobile phone.

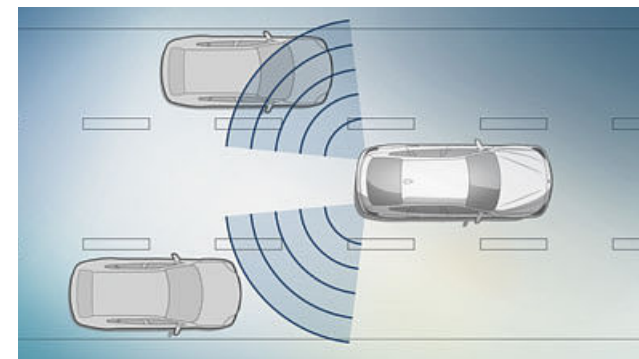

□ **Lane Change Warning** alerts the driver to vehicles in the blind spot as well as vehicles in the neighbouring lane by means of a visual signal and vibration in the steering wheel.

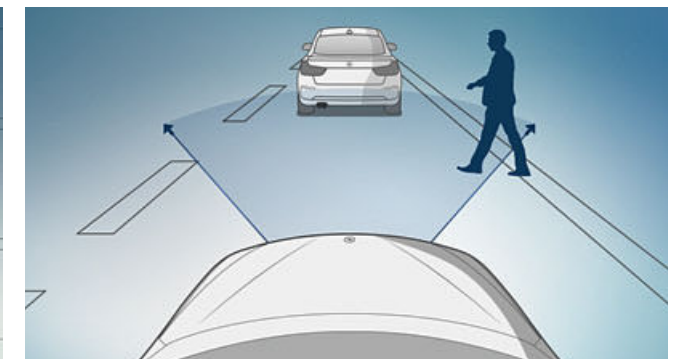

□ **Person warning with light city braking function<sup>1</sup>** notifies drivers of potential collisions with pedestrians and even brakes automatically in emergency situations.

<sup>1</sup> System's function can be restricted at night and in fog.



# INDIVIDUALITY AND CHOICE.

**EQUIPMENT:** BMW models, equipment highlights, wheels and tyres as well as Original BMW Accessories.

**COLOURS:** Exterior and interior colour schemes.

**TECHNICAL DATA:** vehicle weight, engine, transmission, driving performance, consumption, wheels and technical drawings.

**BMW SERVICES:** BMW Service, BMW Financial Services and BMW Experience.



# BASIC.

■ Standard equipment □ Optional equipment

A perfect companion, the new BMW 3 Series Gran Turismo offers a wide range of standard equipment right off the line. Here's a selection of features.

## A selection of base model equipment:

- 17" light alloy wheels
- LED Headlights
- LED foglights
- Leather steering wheel
- Multifunction leather steering wheel
- Armrest, front, sliding
- BMW Professional Radio
- Automatic tailgate operation
- Through-loading system, 40:20:40

01 □



02 ■



03 ■



**[01 | 04]** The BMW 320i in the optional Mineral White metallic exterior colour, shown here with optional 18" light alloy wheels V-Spoke style 658.

**[03]** 17" light alloy wheels Star-spoke style 394, 8J x 17 with 225/55 R17 tyres.<sup>1</sup>

**[02]** The standard LED headlights provide optimal illumination while simultaneously reducing energy consumption.

04 □



05 ■

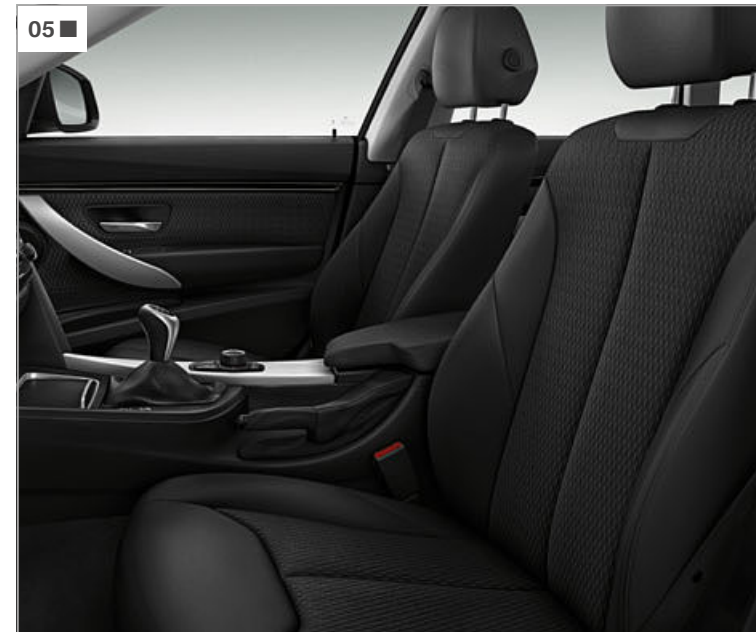

06 ■



**[05]** Standard seats, shown here in Anthracite Move cloth, and the Satin Silver matt interior trim.

**[06]** High-quality materials and perfectly focused driver-orientation exemplify the combination of sportiness and functionality in the new BMW 3 Series Gran Turismo.

<sup>1</sup> Standard with 320i, 320i xDrive, 318d, 320d, 320d xDrive.

Optional and standard equipment vary according to country.



# LUXURY LINE.

■ Standard equipment □ Optional equipment

## Model Luxury Line interior equipment:

- Door sill finishers in aluminium with "BMW" designation
- Seats in Leather ,Dakota' Saddle Brown with extended trims in Brown and Brown highlights; other upholsteries available
- Heated seats
- Sport leather steering wheel
- Car key with Pearl Chrome detailing
- Air conditioning and radio control unit and centre console with Pearl Chrome detailing
- Interior trim finishers in Fine-wood trim ,Fineline' Anthracite with accent in Pearl Chrome or Interior trim finishers in Fine-wood trim burled walnut with accent in Pearl Chrome, the exclusive accent continues on the doors and in the rear; other trims available
- Orange or white variable Ambient light
- B-pillar illumination
- Lights package
- 2-zone Automatic air conditioning with extended features

## Model Luxury Line exterior equipment:

- BMW kidney grille with eleven exclusively designed vertical slats with front sides in Chrome high-gloss
- Front bumper with specific design elements in Chrome high-gloss
- 18" light alloy wheels Multi-spoke style 416, alternatively
- 19" light alloy wheels Multi-spoke style 674 with mixed tyres, other wheels available
- "Luxury Line" designation on the side
- Air Breather in Chrome high-gloss, alternatively in body colour
- Side window frames and window recess finisher in Chrome high-gloss
- Rear bumper with specific design elements in Chrome high-gloss
- Tailpipe trim strip in Chrome high-gloss

03 □



01 □

**[ 01 ]** The Luxury Line offers exclusively sporty character, as seen here with the optional Sport seats and standard Saddle Brown Dakota leather.



02 □

**[ 02 ]** The cockpit with the BMW Individual leather steering wheel in combination with the Fineline light fine-wood trim.



04 ■



05 ■



06 □

**[ 03 | 06 ]** The BMW 330i in the optional Jatoba metallic exterior colour with optional 19" light alloy wheels Multi-spoke style 674 and mixed tyres.

**[ 04 ]** The Automatic air conditioning with two-zone control and automatic temperature control features separate controls for the driver and front passenger. It also includes Automatic Air Recirculation (AAR), an active carbon filter, a fog and solar sensor, as well as rear air vents.

**[ 05 ]** Side "Luxury Line" designation.

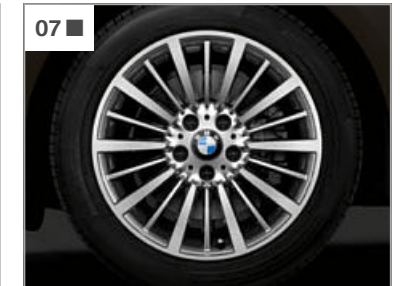

07 ■

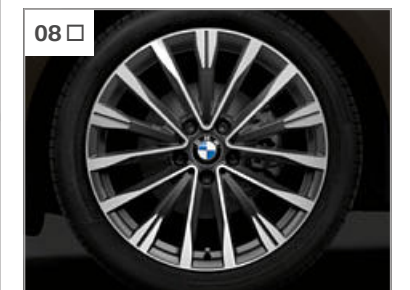

08 □

**[ 07 ]** 18" light alloy wheels Multi-spoke style 416, 8J x 18 with 225/50 R18 tyres.

**[ 08 ]** 19" light alloy wheels Multi-spoke style 674 with mixed tyres in Bicolour Ferric Grey, gloss-lathed, wheel size 8J x 19 front with 225/45 R19 tyres, wheel size 9J x 19 rear with 255/40 R19 tyres.

## SPORT LINE.

■ Standard equipment □ Optional equipment

## Model Sport Line interior equipment:

- Door sill finishers in aluminium with "BMW" designation
- Sport seats in Cloth ‚Corner‘ Anthracite with Red or Grey accent, alternatively Sport seats in Leather ‚Dakota‘ Black with Red accent; other upholsteries available
- Sport leather steering wheel with Red contrast stitching, alternatively available with Black stitching
- Car key with Red detailing
- Instrument cluster with speedometer and revolution counter with chronoscaling and red contrast ring
- Air conditioning and radio control unit with chrome detailing
- Interior trim finishers in Black high-gloss with accent in Coral Red matt or Interior trim finishers in Aluminium, finely brushed lengthwise with accent in Black high-gloss, the exclusive accent continues on the doors and in the rear; other trims available
- Orange or white variable Ambient light
- Driving Experience Control with additional SPORT+ mode
- Lights package
- 2-zone Automatic air conditioning with extended features

## Model Sport Line exterior equipment:

- BMW kidney grille with nine exclusively designed vertical slats with front sides in Black high-gloss
- Front bumper with specific design elements in an Aluminium look and in Black high-gloss
- 18" light alloy wheels Double-spoke style 397 in Bicolour Ferric Grey, alternatively 19" light alloy wheels Double-spoke style 673 with mixed tyres; other wheels available
- "Sport Line" designation on the side
- Mirror caps in body colour, alternatively in Black high-gloss
- Air Breather in Black high-gloss, alternatively in body colour
- Side window surrounds and window recess finisher in Black matt
- Rear bumper with specific design elements in Black high-gloss
- Tailpipe trim strip in Black, chrome-plated

03 □



01 □



[ 01 ] The standard Sport seats, shown here in the optional Oyster Dakota leather, provide outstanding lateral hold thanks to wider side bolsters with electric adjustment.

02 □



[ 02 ] The optional Ash Grain fine-wood interior trim with metal inlay and the Pearl Chrome highlight underscore the dynamics of the interior design. The Sport leather steering wheel convinces with its satisfying grip.

04 ■



05 ■



[ 03 | 06 ] The BMW 340i, shown here with the optional exterior colour Arctic Grey brilliant effect metallic, optional 19" light alloy wheels Double-spoke style 673 with mixed tyres and optional exterior features in satinated Aluminium.

[ 04 ] The Lights package features numerous LED lights both inside and outside for increased convenience and creates a stylish look for the interior.

[ 05 ] The Driving Experience Control features various different modes, so the driver can choose between a comfortable, particularly efficient or superbly sporty drive.

06 □



07 ■



08 □



[ 07 ] 18" light alloy wheels Double-spoke style 397 in Bicolour Ferric Grey, gloss-lathed, 8J x 18, with 225/50 R18 tyres.

[ 08 ] 19" light alloy wheels Double-spoke style 673 in Bicolour Ferric Grey, gloss-lathed, front wheel size 8J x 19 with 225/45 R19 tyres.

# M SPORT PACKAGE.

powered by 

■ Standard equipment □ Optional equipment

## M Sport package interior equipment:

- M door sill finishers, M driver footrest
- Sport seats for driver and front passenger in Cloth/Alcantara combination ,Hexagon' Anthracite with M stitching and Blue accent, alternatively
- Sport seats for driver and front passenger in Leather ,Dakota' Saddle Brown; other upholsteries available
- M Leather steering wheel with multifunction buttons
- BMW Individual headliner Anthracite
- Instrument cluster with speedometer and revolution counter with chronoscaling and red contrast ring
- Air conditioning and radio control unit with chrome detailing
- Interior trim finishers in Aluminium Hexagon with Blue matt accent or Interior trim finishers in Aluminium, finely brushed lengthwise with Black accent, the exclusive accent continues on the doors and in the rear; other trims available
- Shortened gear lever with M designation<sup>1</sup>
- Driving Experience Control with additional SPORT+ mode
- Orange or white variable Ambient light
- Car key with Blue detailing

## M Sport package exterior equipment:

- M Aerodynamics package with front apron, side skirts and rear apron with diffuser insert in Dark Shadow metallic
- BMW kidney grille with nine exclusively designed vertical slats in Black high-gloss
- LED fog lights
- 18" M light alloy wheels Star-spoke style 400 M with mixed tyres, alternatively 19" M light alloy wheels Double-spoke style 598 M with mixed tyres; other wheels available
- M Sport suspension<sup>2</sup>, alternatively Standard running gear or □ Adaptive M suspension<sup>3</sup>
- M Sport brake
- BMW Individual high-gloss Shadow Line
- M designation on the sides
- Exterior mirror caps in body colour
- Tailpipe trim strip in Chrome high-gloss
- Exclusive paintwork in Estoril Blue metallic; other paintworks available
- Air Breather in Black high-gloss

03 □



01 □



**[ 01 ]** The Sport seats in Black Dakota leather with contrast stitching in Blue underscore the powerfully dynamic character of the BMW 3 Series Gran Turismo in the interior.

02 ■



**[ 02 ]** The standard M leather steering wheel with its more pronounced thumbrests is a pleasure to hold. The M footrest, the chrome applications and the Aluminium Hexagon trim with its matt Blue highlight further accentuate the sporty character of the BMW 3 Series Gran Turismo interior.

04 ■



05 ■



**[ 04 ]** BMW Individual headliner Anthracite: the headliner and the trims on the vehicle's pillars and sun visors feature Anthracite cloth.

**[ 05 ]** M Aerodynamics package with larger air inlets, unique side skirts and a rear apron with a diffuser insert in Dark Shadow metallic.<sup>4</sup>

06 □



07 ■



08 □



**[ 07 ]** 18" M light alloy wheels Star-spoke style 400 M with mixed tyres, front 8J x 18 with 225/50 R18 tyres, rear 9J x 18 with 255/45 R18 tyres.

**[ 08 ]** 19" M light alloy wheels Double-spoke style 598 M with mixed tyres Bicolour Orbit Grey, gloss-lathed, wheel size 8J x 19 front with 225/45 R19 tyres, wheel size 9J x 19 rear with 255/40 R19 tyres.

<sup>1</sup> Shortened shift lever only in conjunction with manual transmission.

<sup>2</sup> M Sport suspension not available in conjunction with xDrive.

<sup>3</sup> Lowered suspension not available in combination with xDrive.

<sup>4</sup> Number and design of the tailpipes dependent on engine.

## EQUIPMENT HIGHLIGHTS.

■ Standard equipment □ Optional equipment

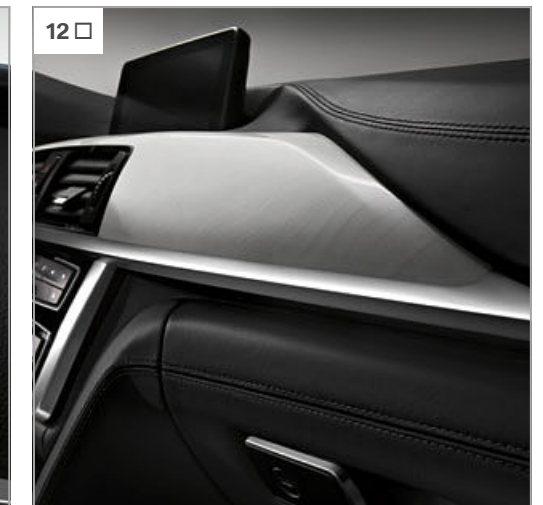
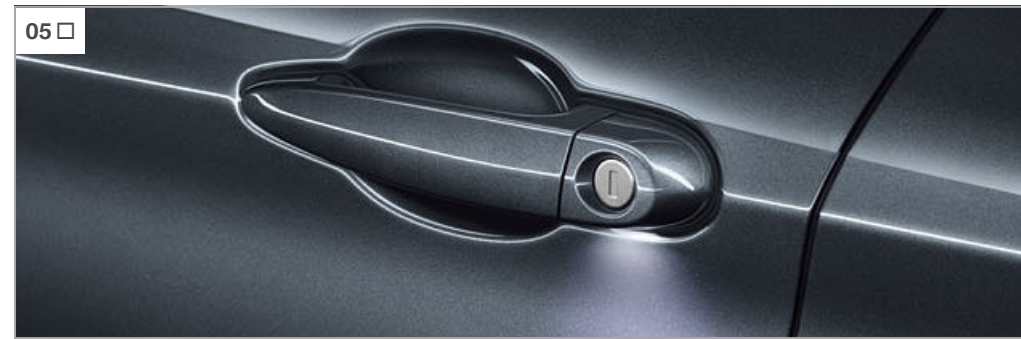

**[ 01 ]** The rear lights with lighting elements in full LED technology with their characteristic "L" shape, make the car instantly recognizable as a BMW, even in the dark.

**[ 02 ]** Interior and driver-side exterior mirrors with automatic anti-dazzle function, including fold-in function for the exterior mirrors and automatic parking function for the front passenger exterior mirror.

**[ 03 ]** The Panorama glass roof with electrically adjustable sunshade not only ensures that both the front and rear have an abundance of light, but also comes with a slide and lift function.

**[ 04 ]** The Adaptive LED headlights produce a light colour very similar to daylight and adjust their light distribution automatically according to speed and steering angle.

**[ 05 ]** The Comfort access system allows passengers to enter the car without having to actively use the car key.

**[ 06 ]** The Rain sensor including automatic headlight activation automatically activates the windscreen wipers and the low-beam headlights.

**[ 07 ]** Tailpipe, visible, twin round, with chrome trim. Shown here with optional trailer tow hitch<sup>1</sup>.

**[ 08 ]** Ash Grain fine-wood trim with metal inlay and Pearl Chrome highlight.

**[ 09 ]** BMW Individual fine-grain leather steering wheel in Sport leather steering wheel design with superior-quality leather and thicker wheel rim.

**[ 10 ]** Telephony with wireless charging offers a comprehensive telephony package with Bluetooth connectivity, an NFC interface and the technical capacity for a WiFi hotspot.<sup>2</sup>

**[ 11 ]** M Leather steering wheel including multifunction buttons, steering wheel rim in leather, 'Walknappa' Black with contoured thumb rests.<sup>3</sup>

**[ 12 ]** BMW Individual instrument panel (4M5) finished with Black Walknappa leather top and bottom. Upper-arm trim panels without leather upholstery. Only in conjunction with Dakota leather.

**[ 13 ]** The full-colour BMW Head-Up Display projects information relevant to the journey directly into the driver's field of vision.<sup>4</sup>

**[ 14 ]** The WLAN Hotspot enables a WLAN connection of up to 10 mobile devices via the SIM card integrated into the vehicle.<sup>5</sup>

<sup>1</sup> The 318d features a left-side single exhaust pipe, 340i and 340i xDrive are fitted with a single exhaust pipe left and right (320i, 320i xDrive, 330i, 330i xDrive, 320d, 320d xDrive, 325d, 330d, 330d xDrive, 335d xDrive have twin pipes). Chromed Black trim for Sport Line models.

<sup>2</sup> Inductive charging in the smartphone holder on the side of the centre console meets the Qi standard for compatible mobile phones. Special holders for selected smartphones without Qi-standard inductive charging functionality are available from BMW Parts and Accessories.

<sup>3</sup> Standard for M Sport package.

<sup>4</sup> The visibility of the BMW Head-Up Display is limited by polarised sunglasses. Functionality shown is dependent on equipment. Further optional equipment is required for additional on-screen functions.

<sup>5</sup> The WLAN Hotspot in the vehicle enables use of the internet with maximum LTE connectivity. Use incurs charges.

Optional and standard equipment vary according to country.

## EQUIPMENT HIGHLIGHTS.

■ Standard equipment □ Optional equipment

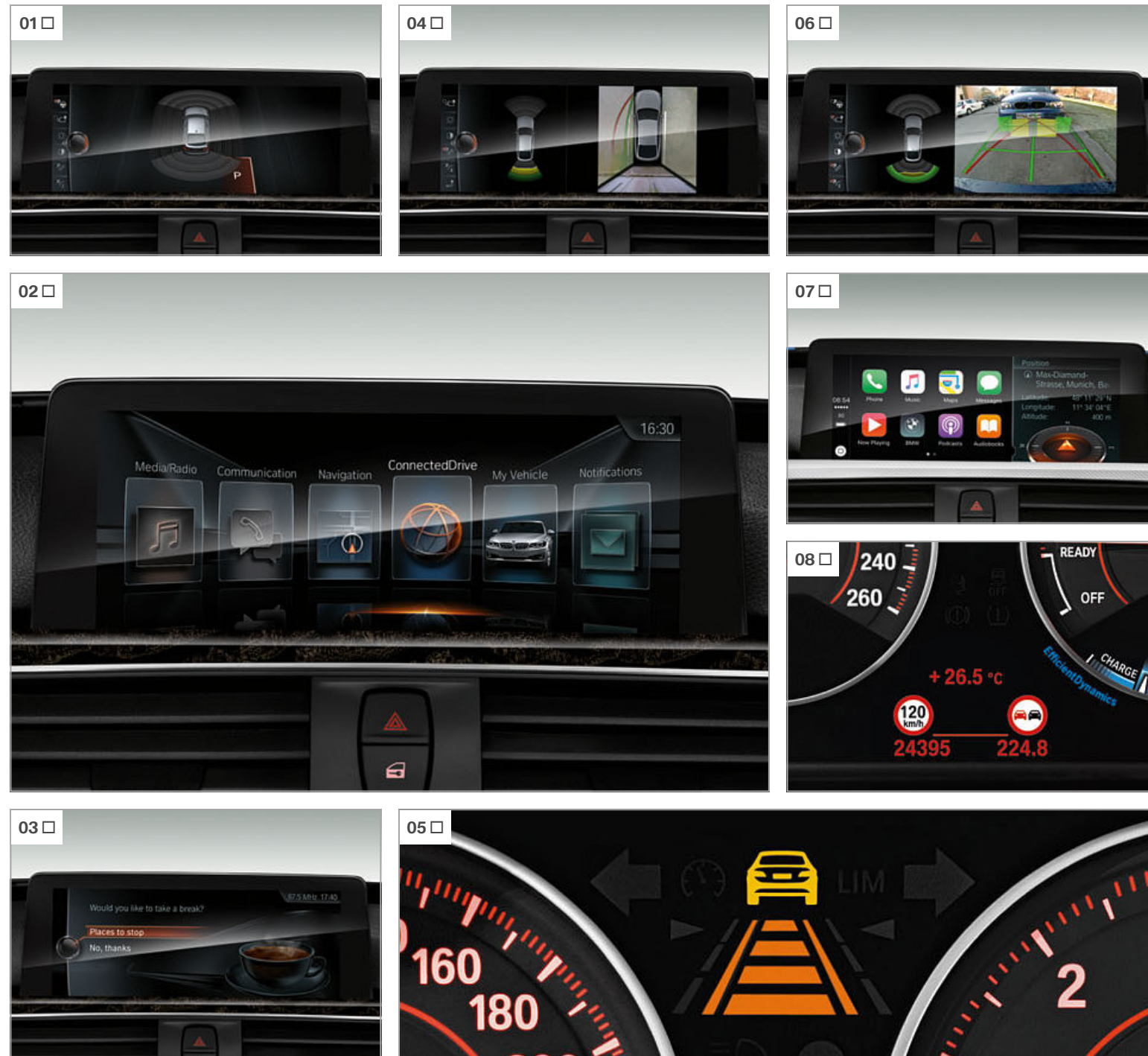

**[ 01 ]** The Parking assistant makes parking parallel and perpendicular to the road easier. It does the steering while the driver remains in control of the accelerator, brake and gears.

**[ 04 ]** Surround View is a visual parking aid with the camera-based functions Top View, Side View and Rear view camera.

**[ 06 ]** The Rear view camera shows the area behind the vehicle on the Control Display. Interactive track lines and obstacle markings also help the driver when reversing.

**[ 02 ]** ConnectedDrive Services forms the basis for intelligent BMW ConnectedDrive functions, as well as for integrating selected smartphone apps.

**[ 05 ]** Active cruise control with Stop&Go function maintains a preselected speed, as well as the distance to the driver ahead.<sup>1</sup>

**[ 07 ]** Preparation for Apple CarPlay® supports the convenient and secure wireless use of an iPhone® via the vehicle's user interface.<sup>2,3,4</sup>

**[ 03 ]** Active Protection warns the driver if it detects signs of tiredness, intervenes in critical situations and brakes the car to a standstill after an accident.

**[ 08 ]** Speed Limit Info including the No-overtaking indicator displays speed limits and provides information on no-overtaking zones.<sup>5</sup>



**[ 09 ]** The Storage compartment package includes items such as practical additional compartments, luggage compartment lashing rails, a storage tray and an additional 12V power socket.<sup>6</sup>

**[ 12 ]** The Through-loading system with rear seat backrests, which are divisible in a 40:20:40 ratio, guarantees flexibility when transporting people and objects.

**[ 14 ]** Harman Kardon surround sound system with 600 watt digital amplifier, vehicle-specific equalising and loudspeakers with chrome detailing.

**[ 10 ]** The Comfort access system allows passengers to enter the car without having to actively use the car key. When the key is on their person, they just have to touch the door handle or tailgate button. Thanks to the Smart Opener and Smart Close functions, the tailgate can also be opened and closed by merely waving one's foot under the rear bumper.

**[ 13 ]** Folding headrests for the three rear seats give the driver a better view through the rear window.

**[ 15 ]** Storage options in the front and rear doors, an open compartment under the centre armrest in the front and in the rear centre console, two cupholders in both the front and rear, along with a storage tray and glove compartment.<sup>8</sup>

**[ 11 ]** Remote backrest unlocking for the rear seats allows the rear seat backrests to be unlocked and folded down conveniently via a button in the luggage compartment.<sup>7</sup>

<sup>1</sup> Only available in conjunction with Steptronic transmission.

<sup>2</sup> ConnectedDrive Services, the Professional Navigation system and Convenience telephony with extended smartphone connectivity are required for use.

<sup>3</sup> Compatibility and functionality of the iPhone® with Apple CarPlay® is dependent on model year and installed software version.

<sup>4</sup> Expected to be available in the second half of 2016.

<sup>5</sup> Only available in conjunction with a BMW navigation system.

<sup>6</sup> Standard for 325d, 330d, 330d xDrive, 335d xDrive, 330i, 330i xDrive, 340i, 340i xDrive.

<sup>7</sup> Included in the storage package.

<sup>8</sup> Shown here with optional smoker's package.

## WHEELS AND TYRES.

■ Standard equipment □ Optional equipment



**[ 01 ]** 17" light alloy wheels Star-spoke style 394, 8J x 17 with 225/55 R17 tyres.<sup>1</sup>

**[ 04 ]** 18" light alloy wheels turbine styling 415, 8J x 18 with 225/45 R18 tyres.

**[ 06 ]** 19" light alloy wheels Double-spoke style 673 in Bicolour Ferric Grey, gloss-lathed, front wheel size 8J x 19<sup>4</sup> with 225/45 R19 tyres.

**[ 02 ]** 17" light alloy wheels V-spoke style 395, 7.5J x 17 with 225/50 R17 tyres.<sup>2</sup>

**[ 05 ]** 19" light alloy wheels Multi-spoke style 674 with mixed tyres in Bicolour Ferric Grey, gloss-lathed, wheel size 8J x 19 front with 225/45 R19 tyres, wheel size 9J x 19 rear with 255/40 R19 tyres.<sup>3</sup>

**[ 07 ]** 19" light alloy wheels Double-spoke style 466 with mixed tyres in Bicolour Ferric Grey, front 8J x 19 with 225/45 R19 tyres, rear 9J x 19 with 255/40 R19 tyres.

**[ 03 ]** 18" light alloy wheels V-spoke style 658, 8J x 18 with 225/50 R18 tyres.

**[ 08 ]** 19" M light alloy wheels Double-spoke style 598 M with mixed tyres Bicolour Orbit Grey, gloss-lathed, wheel size 8J x 19 front with 225/45 R19<sup>5</sup> tyres, wheel size 9J x 19 rear with 255/40 R19 tyres.

<sup>1</sup> Standard for 318d, 320i, 320i xDrive, 320d and 320d xDrive.  
<sup>2</sup> Standard for 330i, 330i xDrive, 340i, 340i xDrive, 325d, 330d, 330d xDrive, 335d xDrive.  
<sup>3</sup> Only available in conjunction with Luxury Line.  
<sup>4</sup> Only available in conjunction with Sport Line.  
<sup>5</sup> Only available in conjunction with M Sport package.

Optional and standard equipment vary according to country.

## ORIGINAL BMW ACCESSORIES.

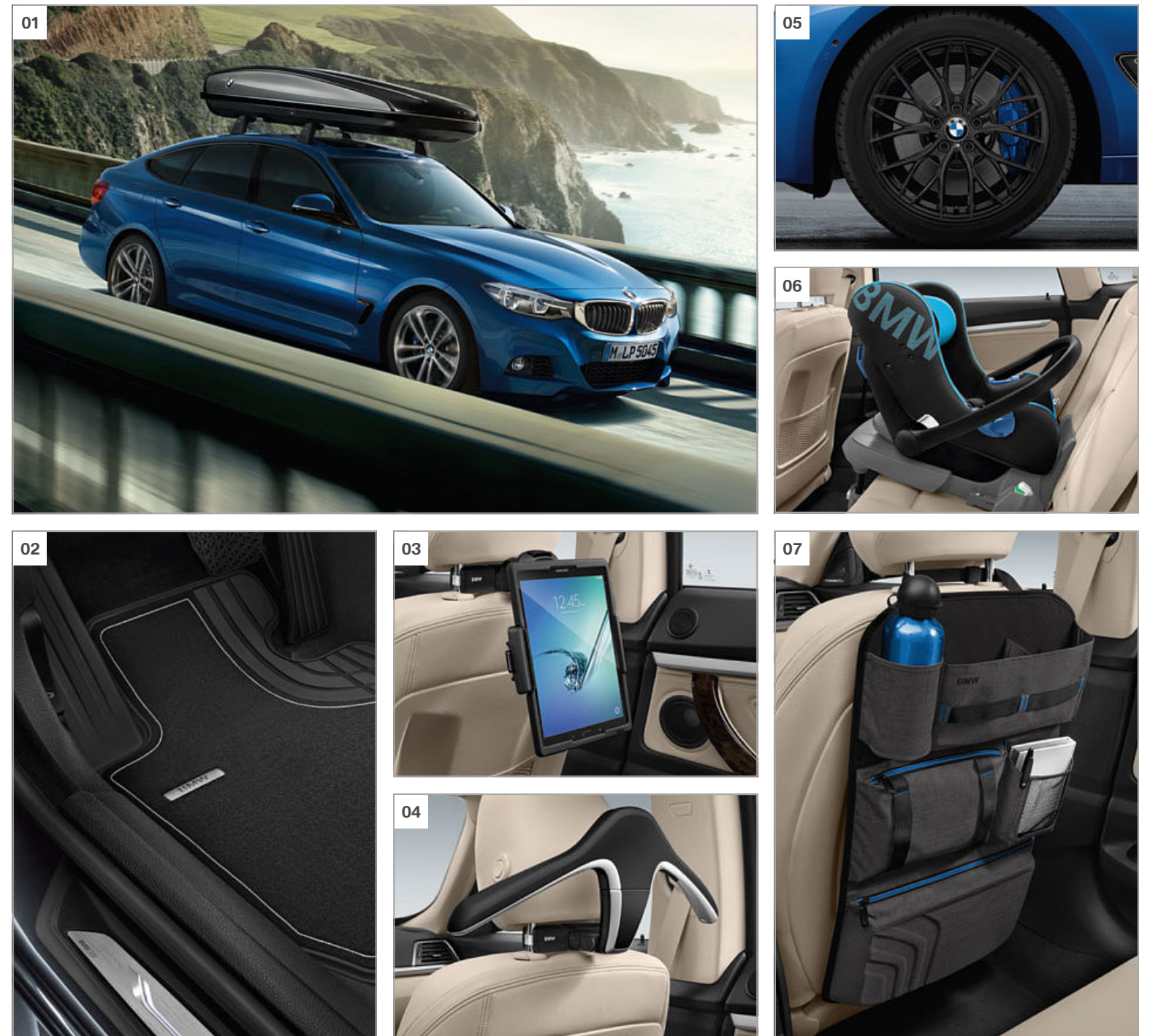

**[ 01 ]** Roof box in Black/Titanium Silver, lockable openings on both sides and with a 520-litre capacity. Suitable for all BMW roof rack systems.

**[ 02 ]** Tailor-made protection from damp, dirt and waterlogging in the front footwell. The black finish is a perfect match with the interior.

**[ 03 ]** Enables headrest attachment of the clothes hanger, the folding table, the universal hooks, the GoPro camera holder or the holder for the Apple iPad™ or Samsung Galaxy Tab.

**[ 04 ]** The clothes hanger attaches to the separately available base carrier (required) using plug-in connectors and can also be used outside the vehicle.

**[ 05 ]** High-quality 18" BMW M Performance light alloy wheels, forged and finished in matt Black. Complete wheel set with run-flat tyres.

**[ 06 ]** Baby seat with patented airpads for children up to 13kg (approx. 15 months). It can be mounted securely either using a separately available ISOFIX base or the seatbelt.

**[ 07 ]** Bag in flecked Black/Grey with storage for various items. It attaches to the front seat and can be folded and carried.

Discover the all-round innovative solutions on offer in many categories: exterior, interior, communication & information and the transport & luggage compartment. Your BMW partner will be happy to advise and can provide a special brochure detailing the entire range of Original BMW Accessories. For more information at any time, go to [www.bmw.com/accessories](http://www.bmw.com/accessories)

# EXTERIOR COLOURS.

■ Standard equipment □ Optional equipment

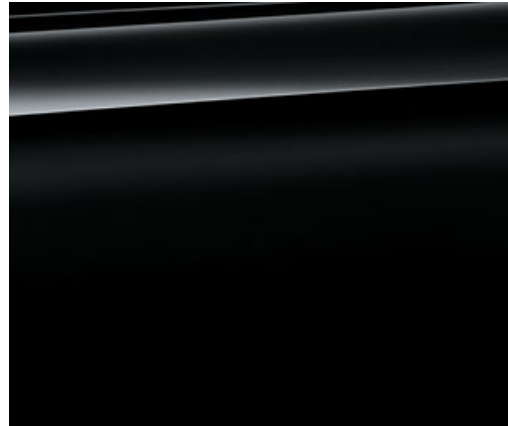

■ Non-metallic 668 Black



□ Non-metallic 300 Alpine White<sup>1</sup>



□ Metallic 475 Black Sapphire



□ Metallic A96 Mineral White

## M SPORT PACKAGE



□ Metallic B45 Estoril Blue



□ Metallic C27 Arctic Grey brilliant effect



□ Metallic B39 Mineral Grey<sup>2</sup>



□ Metallic A89 Imperial Blue brilliant effect



□ Metallic A75 Melbourne Red<sup>2</sup>



□ Metallic B65 Jatoba



□ Metallic 481 Kalahari Beige



□ Metallic A83 Glacier Silver<sup>2</sup>

<sup>1</sup> Standard with M Sport package.  
<sup>2</sup> Optionally available for M Sport packages.

Optional and standard equipment vary according to country.

**[ Colours ]** The colours printed above are intended to provide you with a first impression of paints and materials available for your BMW. Experience has shown, however, that printed images of paint, upholstery and interior trim colours cannot faithfully reproduce the actual appearance of the originals. We recommend therefore that you consult your BMW partner who will be able to show you original samples and assist with special requests.

# INTERIOR COLOURS.

■ Standard equipment □ Optional equipment

## CLOTH

| Available with          |  |
|-------------------------|--|
| ■ Basic                 | <b>Move cloth</b><br>BDAT Anthracite <sup>1</sup>          |
| □ Basic<br>■ Sport Line | <b>Corner cloth</b><br>CCL1 Anthracite with Grey highlight |
| ■ Sport Line            | <b>Corner cloth</b><br>CCL2 Anthracite with Red highlight  |

## CLOTH/LEATHER COMBINATION

| Available with          |  |
|-------------------------|--|
| □ Basic<br>□ Sport Line | <b>Breeze cloth-leather combination</b><br>CBAT Anthracite with interior colour in Black             |
| □ Basic<br>□ Sport Line | <b>Cloth-leather combination Breeze</b><br>CBOP Oyster with lower part of instrument panel in Oyster |
| ■ M Sport package       | <b>Hexagon cloth-Alcantara combination</b><br>HAAT Anthracite  |

## LEATHER

| Available with  |  |
|---|--|
| □ Basic<br>■ Luxury Line<br>□ Sport Line                      | <b>Dakota leather</b><br>LCV1 Veneto Beige with interior colour in Black   |
| □ Basic<br>■ Luxury Line<br>□ Sport Line                      | <b>Dakota leather</b><br>LCDF Veneto Beige with interior colour in Veneto Beige                                    |
| □ Basic<br>■ Luxury Line<br>□ Sport Line<br>□ M Sport package | <b>Dakota leather</b><br>LCSW Black with interior colour in Black  |
| □ Basic<br>■ Luxury Line<br>□ Sport Line<br>□ M Sport package | <b>Dakota leather</b><br>LCOM Oyster with Dark Oyster highlight and lower part of instrument panel in Oyster       |
| ■ Luxury Line<br>□ Sport Line<br>□ M Sport package            | <b>Dakota leather</b><br>LCFJ Veneto Beige with Dark Oyster highlight and equipment parts in Veneto Beige          |
| ■ Luxury Line<br>□ Sport Line<br>□ M Sport package            | <b>Dakota leather</b><br>LCFL Veneto Beige with Dark Oyster highlight and equipment parts in Black                 |
| □ Sport Line<br>□ M Sport package                             | <b>Dakota leather</b><br>LCL5 Coral Red with Black highlight   |
| □ Sport Line<br>□ M Sport package                             | <b>Dakota leather</b><br>LCDJ Saddle Brown with Brown highlight and lower part of instrument panel in Black        |
| ■ Luxury Line   | <b>Dakota leather</b><br>LCDY Saddle Brown with Brown highlight and lower part of instrument panel in Saddle Brown |
| ■ Luxury Line<br>□ Sport Line<br>□ M Sport package            | <b>Dakota leather</b><br>LCL8 Black with Dark Oyster highlight   |
| □ Sport Line  | <b>Dakota leather</b><br>LCL3 Black with Red highlight   |
| □ M Sport package   | <b>Dakota leather</b><br>LCNL Black with contrast stitching in Blue  |



## INTERIOR TRIMS

| Available with  |  |
|---|--|
| ■ Basic   | 4CG Satin Silver matt  |
| ■ Sport Line  | 4LV Black high-gloss with Coral Red matt highlight                 |
| □ Basic<br>■ Luxury Line<br>■ Sport Line                      | 4LU Black high-gloss with Pearl Chrome highlight                   |
| □ Basic<br>■ Luxury Line<br>□ Sport Line<br>■ M Sport package | 4LS Fine-brushed Aluminium with Pearl Chrome highlight             |
| □ Basic<br>■ Luxury Line<br>□ Sport Line<br>■ M Sport package | 4FT Fine-brushed Aluminium with high-gloss Black highlight         |
| ■ M Sport package   | 4WF Aluminium Hexagon with matt Blue highlight                     |
| ■ M Sport package   | 4WG Aluminium Hexagon finisher with high-gloss Black highlight     |
| □ Basic<br>■ Luxury Line<br>□ Sport Line<br>□ M Sport package | 4FU FineLine Anthracite fine-wood trim with Pearl Chrome highlight |
| □ Basic<br>■ Luxury Line<br>□ Sport Line<br>□ M Sport package | 4FV FineLine light with Pearl Chrome highlight                     |

| Available with  |   |
|---|---|
| □ Basic<br>■ Luxury Line<br>□ Sport Line<br>□ M Sport package | 4FW Burr Walnut fine-wood trim with Pearl Chrome highlight                |
| □ Luxury Line<br>□ Sport Line<br>□ M Sport package            | 4GA Ash Grain fine-wood trim with metal inlays and Pearl Chrome highlight |

## BMW INDIVIDUAL INTERIOR TRIMS

| Available with  |   |
|---|---|
| □ Basic<br>□ Luxury Line<br>□ Sport Line<br>□ M Sport package | <b>BMW Individual interior trim</b><br>XEX Fine-wood trim Ash Grain White, Pearl-Gloss Chrome accent line   |
| □ Basic<br>□ Luxury Line<br>□ Sport Line<br>□ M Sport package | <b>BMW Individual interior trim</b><br>XE5 Fine-wood trim Plane Auburn dark, Pearl-Gloss Chrome accent line |
| □ Basic<br>□ Luxury Line<br>□ Sport Line<br>□ M Sport package | <b>BMW Individual interior trim</b><br>XE7 Piano finish Black, Pearl-Gloss Chrome accent line               |

## BMW INDIVIDUAL HEADLINER

| Available with  |   |
|---|---|
| □ Basic<br>□ Luxury Line<br>□ Sport Line<br>■ M Sport package | <b>BMW Individual headliner</b><br>775 Anthracite |

Please note that even normal long or short-term use can lead to unrecoverable upholstery damage. This can be caused in particular by non-colourfast clothing.

<sup>1</sup> Only available in conjunction with standard seats.

Optional and standard equipment vary according to country.

Please note that the interior colour and headliner depend on the selected upholstery colour.



|  |  |                             |                             |                             |             |                             |             |                             |                    |
|--|--|-----------------------------|-----------------------------|-----------------------------|-------------|-----------------------------|-------------|-----------------------------|--------------------|
|  |  | <b>320i<br/>320i xDrive</b> | <b>330i<br/>330i xDrive</b> | <b>340i<br/>340i xDrive</b> | <b>318d</b> | <b>320d<br/>320d xDrive</b> | <b>325d</b> | <b>330d<br/>330d xDrive</b> | <b>335d xDrive</b> |
|--|--|-----------------------------|-----------------------------|-----------------------------|-------------|-----------------------------|-------------|-----------------------------|--------------------|

| Weight  |    |                          |             |             |                          |                          |             |             |             |
|---|----|--------------------------|-------------|-------------|--------------------------|--------------------------|-------------|-------------|-------------|
| Unladen EU  | kg | 1655 [1675]              | [1695]      | [1735]      | 1645 [1670]              | 1655 [1670]              | [1705]      | [1735]      | -           |
| Unladen EU <sup>1</sup> (xDrive)  | kg | 1735 [1750]              | [1760]      | [1800]      | -                        | 1720 [1735]              | -           | [1805]      | [1820]      |
| Max. permissible  | kg | 2150 [2170]              | [2190]      | [2230]      | 2140 [2165]              | 2150 [2165]              | [2200]      | [2230]      | -           |
| Max. permissible (xDrive)   | kg | 2230 [2245]              | [2255]      | [2295]      | -                        | 2215 [2230]              | -           | [2300]      | [2315]      |
| Permitted load  | kg | 570 [570]                | [570]       | [570]       | 570 [570]                | 570 [570]                | [570]       | [570]       | -           |
| Permitted load (xDrive)   | kg | 570 [570]                | [570]       | [570]       | -                        | 570 [570]                | -           | [570]       | [570]       |
| Permitted trailer load, unbraked  | kg | 695 [695]                | [745]       | [750]       | 745 [745]                | 745 [745]                | [750]       | [750]       | -           |
| Permitted trailer load, unbraked <sup>2</sup> (xDrive)                          | kg | 750 [750]                | [750]       | [750]       | -                        | 750 [750]                | -           | [750]       | [750]       |
| Permitted trailer load, braked, max. 12% gradient/<br>max. 8% gradient          | kg | 1400/1600<br>[1500/1600] | [1600/1700] | [1700/1800] | 1600/1700<br>[1600/1700] | 1600/1800<br>[1600/1800] | [1800/1800] | [1800/1800] | -           |
| Permitted trailer load, braked, max. 12% gradient/<br>max. 8% gradient (xDrive) | kg | 1700/1800<br>[1700/1800] | [1700/1800] | [1800/1800] | -                        | 1600/1800<br>[1600/1800] | -           | [1800/1800] | [1800/1800] |
| Luggage compartment volume, seat-backs min.-max.                                | l  | 520-1600                 | 520-1600    | 520-1600    | 520-1600                 | 520-1600                 | 520-1600    | 520-1600    | 520-1600    |

| Engine <sup>3,4</sup>           |                 |   |                    |                    |                    |                    |                    |                    |                    |
|---------------------------------|-----------------|---|--------------------|--------------------|--------------------|--------------------|--------------------|--------------------|--------------------|
| Cylinders/valves                |                 | 4/4   | 4/4                | 6/4                | 4/4                | 4/4                | 4/4                | 6/4                | 6/4                |
| Capacity                        | cc              | 1998  | 1998               | 2998               | 1995               | 1995               | 1995               | 2993               | 2993               |
| Rated output/rated engine speed | kW (hp)/<br>rpm | 135 (184)/<br>5000                            | 185 (252)/<br>5200 | 240 (326)/<br>5500 | 110 (150)/<br>4000 | 140 (190)/<br>4000 | 165 (224)/<br>4400 | 190 (258)/<br>4000 | 230 (313)/<br>4400 |
| Max. torque/engine speed        | Nm/rpm          | 270/1350-4600<br>(290/1350-4250) <sup>5</sup> | 350/<br>1450-4800  | 450/<br>1380-5000  | 320/<br>1500-3000  | 400/<br>1750-2500  | 450/<br>1500-3000  | 560/<br>1500-3000  | 630/<br>1500-2500  |

| Power transmission             |  |                      |                        |                        |                  |                      |                        |                        |                        |
|--------------------------------|--|----------------------|------------------------|------------------------|------------------|----------------------|------------------------|------------------------|------------------------|
| Drive configuration            |  | Rear-wheel/all-wheel | Rear-wheel/all-wheel   | Rear-wheel/all-wheel   | Rear-wheel       | Rear-wheel/all-wheel | Rear-wheel             | Rear-wheel/all-wheel   | All-wheel              |
| Standard transmission          |  | Six-speed manual     | Eight-speed Steptronic | Eight-speed Steptronic | Six-speed manual | Six-speed manual     | Eight-speed Steptronic | Eight-speed Steptronic | -                      |
| Standard transmission (xDrive) |  | Six-speed manual     | Eight-speed Steptronic | Eight-speed Steptronic | -                | Six-speed manual     | -                      | Eight-speed Steptronic | Eight-speed Steptronic |

| Performance                     |      |           |                     |                     |           |           |       |                     |                     |
|---------------------------------|------|-----------|---------------------|---------------------|-----------|-----------|-------|---------------------|---------------------|
| Top speed                       | km/h | 230 [229] | [250 <sup>6</sup> ] | [250 <sup>6</sup> ] | 210 [210] | 230 [226] | [240] | [250 <sup>6</sup> ] | -                   |
| Top speed (xDrive)              | km/h | 227 [224] | [250 <sup>6</sup> ] | [250 <sup>6</sup> ] | -         | 230 [225] | -     | [250 <sup>6</sup> ] | [250 <sup>6</sup> ] |
| Acceleration 0-100km/h          | s    | 8.0 [8.1] | [6.1]               | [5.1]               | 9.3 [9.2] | 7.8 [7.7] | [6.4] | [5.7]               | -                   |
| Acceleration 0-100km/h (xDrive) | s    | 8.1 [8.4] | [6.2]               | [5.0]               | -         | 7.8 [7.7] | -     | [5.4]               | [4.9]               |

| Fuel consumption <sup>3,4</sup>              |         |                      |           |            |                      |                      |           |           |           |
|--|---------|----------------------|-----------|------------|----------------------|----------------------|-----------|-----------|-----------|
| Urban  | l/100km | 7.7-8.1<br>[6.9-7.3] | [7.3-7.7] | [9.5-9.8]  | 5.3-5.6<br>[4.9-5.2] | 5.5-5.7<br>[5.0-5.4] | [5.3-5.5] | [6.1-6.3] | -         |
| Urban (xDrive)                               | l/100km | 8.6-9.0<br>[7.8-8.1] | [7.9-8.3] | [9.6-10.1] | -                    | 5.7-6.0<br>[5.3-5.6] | -         | [6.4-6.6] | [6.6-6.7] |
| Extra-urban                                  | l/100km | 5.1-5.4<br>[5.1-5.4] | [5.0-5.3] | [5.5-5.8]  | 4.0-4.1<br>[3.9-4.1] | 4.1-4.3<br>[3.9-4.1] | [4.4-4.7] | [4.6-4.7] | -         |
| Extra-urban (xDrive)                         | l/100km | 5.6-5.9<br>[5.4-5.7] | [5.4-5.7] | [6.0-6.3]  | -                    | 4.3-4.5<br>[4.1-4.3] | -         | [4.8-5.0] | [5.1-5.2] |
| Combined                                     | l/100km | 6.1-6.4<br>[5.8-6.1] | [5.9-6.2] | [7.0-7.3]  | 4.5-4.7<br>[4.3-4.5] | 4.6-4.8<br>[4.3-4.6] | [4.7-5.0] | [5.1-5.3] | -         |
| Combined (xDrive)                            | l/100km | 6.7-7.1<br>[6.3-6.6] | [6.3-6.7] | [7.4-7.7]  | -                    | 4.8-5.1<br>[4.5-4.8] | -         | [5.4-5.6] | [5.6-5.7] |
| CO <sub>2</sub> emissions, combined          | g/km    | 139-146<br>[132-139] | [134-141] | [159-166]  | 117-123<br>[112-119] | 120-127<br>[113-120] | [124-131] | [135-139] | -         |
| CO <sub>2</sub> emissions, combined (xDrive) | g/km    | 154-161<br>[144-151] | [145-152] | [168-175]  | -                    | 126-133<br>[119-126] | -         | [142-146] | [148-151] |
| Tank capacity (approx.)                      | l       | 60                   | 60        | 60         | 57                   | 57                   | 57        | 57        | 57        |

|  |  |                             |                             |                             |             |                             |             |                             |                    |
|--|--|-----------------------------|-----------------------------|-----------------------------|-------------|-----------------------------|-------------|-----------------------------|--------------------|
|  |  | <b>320i<br/>320i xDrive</b> | <b>330i<br/>330i xDrive</b> | <b>340i<br/>340i xDrive</b> | <b>318d</b> | <b>320d<br/>320d xDrive</b> | <b>325d</b> | <b>330d<br/>330d xDrive</b> | <b>335d xDrive</b> |
|--|--|-----------------------------|-----------------------------|-----------------------------|-------------|-----------------------------|-------------|-----------------------------|--------------------|

| Wheels/tyres     |  |               |               |               |               |               |               |               |               |
|------------------|--|---------------|---------------|---------------|---------------|---------------|---------------|---------------|---------------|
| Tyre dimensions  |  | 225/55 R 17 V | 225/55 R 17 W | 225/55 R 17 W | 225/55 R 17 V | 225/55 R 17 V | 225/55 R 17 W | 225/55 R 17 W | 225/55 R 17 W |
| Wheel dimensions |  | 8 J x 17      | 8 J x 17      | 8 J x 17      | 8 J x 17      | 8 J x 17      | 8 J x 17      | 8 J x 17      | 8 J x 17      |
| Material         |  | Light alloy   | Light alloy   | Light alloy   | Light alloy   | Light alloy   | Light alloy   | Light alloy   | Light alloy   |

<sup>1</sup> Figure quoted accounts for a 90% full tank, 68kg for the driver and 7kg of luggage. Unladen weight applies to vehicles with standard equipment. Optional equipment may increase these figures.  
<sup>2</sup> The actual overall trailer weight may not exceed the max. permitted trailer load, while taking into account the max. permitted towbar download. The max. trailer load of 2,400kg only applies in conjunction with a factory-fitted trailer tow hitch and automatic transmission.  
<sup>3</sup> BMW recommends the use of RON 95 super unleaded petrol. Unleaded RON 91 and higher with a maximum ethanol content of 10% (E10) may also be used. Output and fuel consumption figures apply to RON 98 fuel.

<sup>4</sup> All engines comply with the EU6 emissions standard. Fuel consumption is determined in accordance with the ECE driving cycle in which approx. one-third of the distance covered is in urban traffic and two-thirds is extra-urban. CO<sub>2</sub> emissions are measured in addition to fuel consumption. Fuel consumption and CO<sub>2</sub> emissions are dependent on wheel and tyre size. Optional equipment may increase these figures.  
<sup>5</sup> Different value applies to BMW 320i with manual transmission.  
<sup>6</sup> Electronically restricted.

Figures in [ ] refer to vehicles with Steptronic transmission.

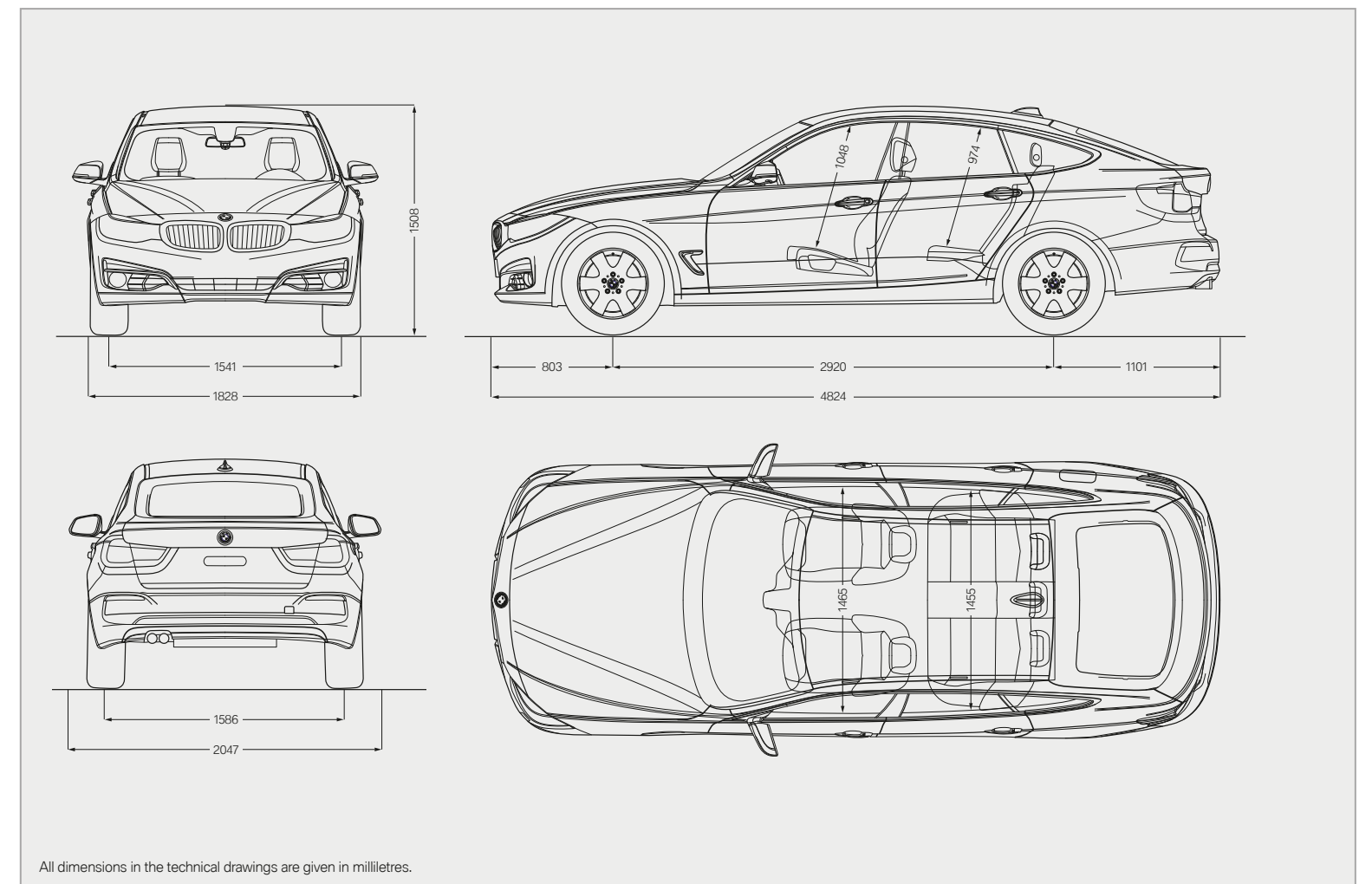

All dimensions in the technical drawings are given in millimetres.

## WELL TAKEN CARE OF WITH BMW SERVICES:

When you buy a BMW, you can look forward to superb service and comprehensive customer care. For example, the **Condition Based Service** independently tracks both service fluid levels and the condition of parts subject to wear and then notifies you in the display when the vehicle requires servicing. So you only need to go to your BMW service partner when it's really necessary. When you do go, our

**qualified BMW service specialists** take care of your vehicle using the newest workshop technology and only **original BMW parts**. This service is available worldwide in more than 3,300 BMW service partner establishments in over 150 countries, to provide you with limitless driving pleasure.

### BMW SERVICE.



**BMW Service Packages\*:** Individual and stress-free, just for you. Individual, well-thought-out servicing solutions carefully tailored to you and your vehicle. With one-off, predictable costs, BMW Service Packages give you complete peace of mind, so you can enjoy owning a BMW to the very fullest. Whether it's fresh from the showroom or already well-travelled – there's a BMW Service Package for every phase of your vehicle's life. All bringing you maximum quality, expertise and value retention, always at reasonable, transparent rates. And always carefully tailored to you and your BMW. Find out just how stress-free truly individual service can be!

[www.bmw.com/serviceinclusive](http://www.bmw.com/serviceinclusive)



**BMW Mobile Service\*:** This service is there for you day and night. As soon as you call, we spring into action, and take care of everything that may need doing after an accident or breakdown, with specially trained technicians working – on site or via telephone – to get your car back on the road. We offer comprehensive, country-specific mobility packages for breakdowns, and insurance that covers you in the event of an accident or theft. So if anything untoward does happen, simply call up the BMW accident hotline and we'll go to work. We'll take care of calling the emergency services, a tow truck, a replacement car, notifying your insurance company and much more. For further information please visit [www.bmw.com](http://www.bmw.com)



**BMW TeleServices\*:** With Condition Based Service, you'll be automatically reminded of your next necessary service appointment on the vehicle screen. Provided you've consented, key vehicle data will be relayed to BMW automatically for analysis. Your assigned BMW service partner will access the information and contact you free of charge to make a service appointment as and when necessary. To access BMW Teleservices, the vehicle must be equipped with the optional Intelligent Emergency Call or ConnectedDrive Services. The service can be deactivated at any time you so desire, and you can change your service partner in the iDrive menu or ConnectedDrive portal. Find out more at [www.bmw.com/teleservices](http://www.bmw.com/teleservices)

### BMW FINANCIAL SERVICE.



**BMW Financial Services\*:** Mobility solutions to meet your needs. BMW Financial Services provides you with attractive leasing, finance and insurance options. To find out more, see the price list or go to [www.bmwfs.com](http://www.bmwfs.com). Your BMW partner will also be glad to draw up an individual offer for you in person.

### THE BMW EXPERIENCE.



**BMW TV\*:** [www.bmw.tv](http://www.bmw.tv) enables you to experience the BMW brand in all its diversity. Features, portraits and background reports provide you with information on automobiles, innovations, sports and lifestyle topics.



**BMW Driving Experience:** The better you control your BMW, the more enjoyment you will derive from driving it. Use our training courses to learn for yourself what it means to reach a car's physical limits on various types of surfaces, and what you have to do to control your vehicle even in extreme situations. For further information please visit [www.bmwdrivingexperience.com](http://www.bmwdrivingexperience.com)



**BMW Welt:** Picking up a car at BMW Welt has always ranked among the best moments for any driver. Turn this moment into one whole unforgettable day: experience the handover of your new BMW as just one part of a programme of activities perfectly tailored to your interests. At BMW Welt, the BMW Group plant, the BMW Museum, the BMW Group headquarters and the BMW Group Classic all combine to provide you with a great experience of an exciting history, a breathtaking present – and spectacular visions for the future. Find out more at [www.bmw-welt.com/en](http://www.bmw-welt.com/en)



**BMW Magazine:** In BMW Magazine, experience the newest BMW models in front of stunning backdrops. Discover new design trends, travel destinations and the richness of modern life. Encounter people with visionary ideas who are changing the world. Find out more at [www.bmw.com/magazine](http://www.bmw.com/magazine)

\* May not be available in all countries. Please consult your BMW partner.

## SHAPING THE FUTURE – RESPONSIBLY.

In 2015, the BMW Group was once more listed in the Dow Jones Sustainability Index as the most sustainable automotive company worldwide. This makes BMW Group the only company in the automotive industry to be listed without interruption since the index was established. The development of efficient vehicle concepts and environmentally friendly production processes, including recycling, is an integral part of our philosophy. BMW EfficientDynamics and electric vehicles have enabled us to cut CO<sub>2</sub> emissions from our European new-vehicle fleet by more than 40% since 1995. We have also reduced the amount of resources used in production, such as water and energy, by 34% between 2006 and 2015, with a reduction to 45% of previous levels aimed at for 2020. In terms of other resources (such as volatile organic compounds, process wastewater and waste) our 45% target was met in 2014, and we will continue to work on further improvement. Production at our engine plant in Steyr has been waste-water free since 2007. And of course, at the end of its service life, every one of our vehicles can be easily and economically recycled. To return your end-of-life vehicle, please contact your BMW partner. For more information on this issue please visit our website.

[www.bmw.com/EfficientDynamics](http://www.bmw.com/EfficientDynamics)  
[www.bmwgroup.com/responsibility](http://www.bmwgroup.com/responsibility)  
[www.bmw.com/recycling](http://www.bmw.com/recycling)

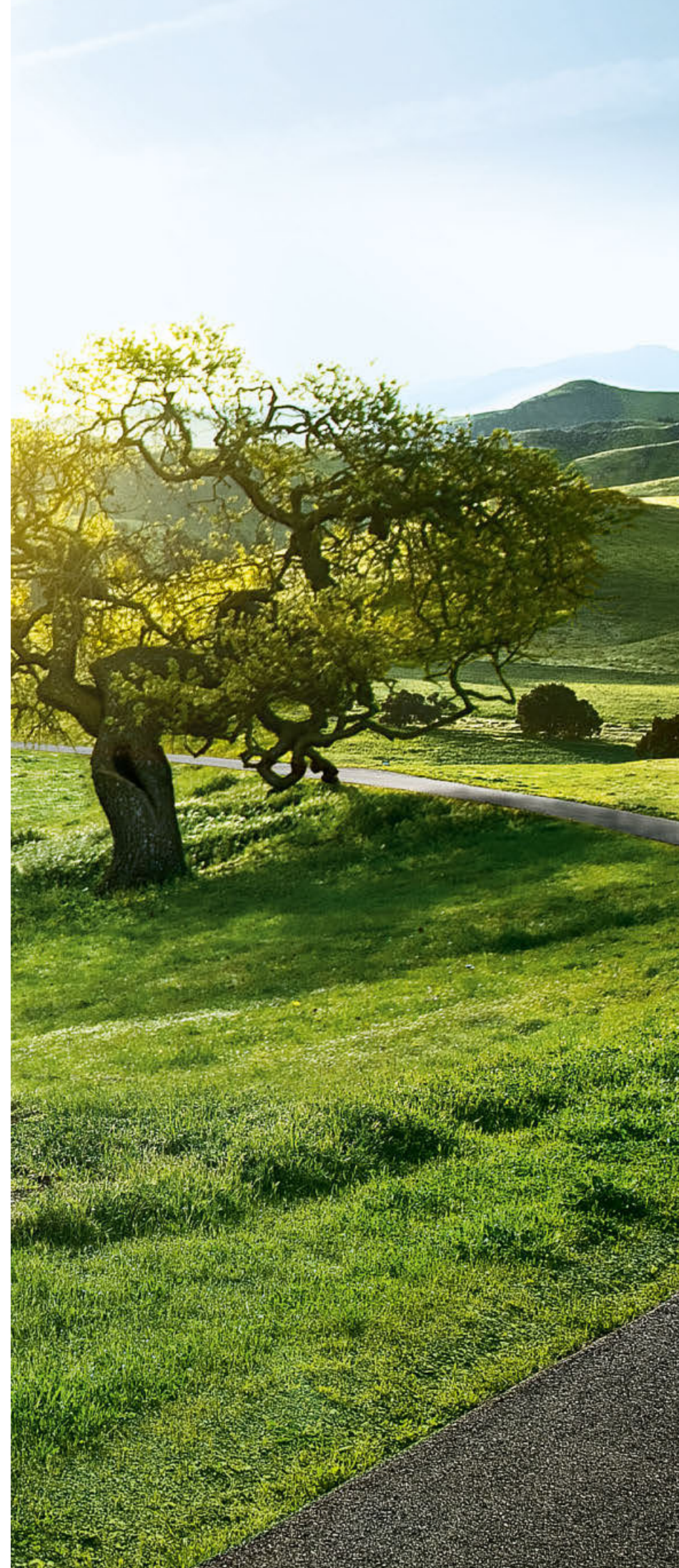

More about BMW



Sheer  
Driving Pleasure

[www.bmw.com](http://www.bmw.com)

The models illustrated in this brochure show the specifications and configurations (standard and optional equipment) of vehicles produced by BMW AG for the German market. According to the specific requirements of other markets, alterations in standard and optional equipment and the configurations available for the different models, as described in this brochure, may occur. For more precise information about country-specific vehicle versions, please contact your local BMW partner. Subject to change in design and equipment.

© BMW AG, Munich/Germany. Not to be reproduced wholly or in part without written permission of BMW AG, Munich.

4 11 003 32820 2 2016 BM. Printed in Germany 2016.

